



# HunGarian Baja.com

FIM Cross-Country Bajas World Cup  
FIA European Cup for Cross-Country Bajas



# RALLY GUIDE

10-12 August 2023.

www.hungarianbaja.com  
info@hungarianbaja.com







## INDEX

1

## TARTALOM

2. WELCOME NOTES / KÖSZÖNTŐ .....	3
3. INTRODUCTION / BEVEZETÉS .....	5
4. PAST WINNERS / ELŐZŐ NYERTESEK .....	5
5. ELÉRHETŐSÉGEK / CONTACT DETAILS.....	8
6. OFFICIAL LOCATIONS / HELYSZÍNEK .....	9
7. PROGRAMME / PROGRAM .....	10
8 SHAKEDOWN / TESZT .....	11
9. USEFUL FACTS / FONTOS TUDNIVALÓK .....	11
10. XX.HUNGARIAN BAJA.....	13
11. ITINERARY / IDŐTERV .....	15
12. MAPS.....	17
13. GPS navigation and safety tracking system STELLA.....	18
14. GPS navigation and safety tracking system's installation kit .....	30

Ez a dokumentum csak informatív jellegű, megjelent 2023. 06. 01

This document is for informational purposes only, has no regulatory power and was published on June 1, 2023

VAN JOBB ÖTLETÜNK  
A VASPÓTLÁSRA.\*



## BIOEXTRA FERROVIT

Szerves vas tartalmú étrend-kiegészítő  
ásványi anyagokkal és vitaminokkal:



B<sub>6</sub> és B<sub>12</sub>-vitamin, Folsav



TÖRÖDÜNK AZ EGÉSZSÉGGEL [www.bioextra.hu](http://www.bioextra.hu) MAGYAR GYÁRTÓ

\*A Bioextra Ferrovit szerves vasat és vitaminokat, ásványi anyagokat tartalmazó komplex vaskészítmény, amely támogatja a szervezet számára nélkülözhetetlen vas pótlását, hozzájárul az immunrendszer normál működéséhez, valamint a normál vörösvérsejt- és hemoglobin-képződéshez. A vas, a réz, a cink, valamint a B<sub>6</sub>- és B<sub>12</sub>-vitaminok hozzájárulnak az immunrendszer normál működéséhez. A vas hozzájárul a normál vörösvérsejt- és hemoglobin képződéshez.

Az étrend-kiegészítő használata nem helyettesíti a kiegyensúlyozott, vegyes étrendet és az egészséges életmódot.



## WELCOME NOTES

2

## KÖSZÖNTŐ

The twentieth... Hmm...

I would like to come up with some thoughts and share them with you, but it seems that these thoughts never come at times like this. I have gained countless memories from this sport and from all of you who are reading these lines, from those with whom we have been organizing the HunGarian Baja for 20 years now, and from those who have participated only on a few occasions. I remember everything and everyone! I even wrote down your names in a few places... You can check them out, too! Each day of these 20 years feels like it was just yesterday. Great sporting successes have been achieved, and there were times when the event was only saved by luck despite our best knowledge and efforts. Several times we had to move with the race, and we travelled through this wonderfully beautiful country together with you.



I consider myself very fortunate, because ever since I was a child, I have been playing and engaging in the best ever job, the most beautiful, but also difficult game for me. 21 years ago, I moved to Veszprém from Budapest, because I fell in love with the endless waves of the Shooting Range, the Bakony Mountains, Lake Balaton and the entire region. I felt that I would find my home here, my family, and that I would be able to fulfil all my dreams. And so, it happened!

Sometimes I'm foolish and stubborn. There is no other way for me, only mine. However, this is one of the reasons, why we were able to reach such an anniversary, which I could still hardly believe. At the beginning, it seemed like a dream out of touch with reality, and we could only hope that one day the HunGarian Baja would reach three or maybe five years. Well, now it's the 20th...

However, there is another and perhaps the most important miracle in my life to whom we can be grateful. They are my family! My wife Eszter, my older son Oliver, and my younger son Martin. Thank you for loving and putting up with this fool.

You can read everything else in the Supplementary Regulation and press materials.

I WISH YOU A SAFE AND HAPPY BIRTHDAY, HUNGARIAN BAJA!

Sincerely yours,  
Garamvölgyi Zoltán  
Event Director



A huszadik... Hmm...

Szeretnék nagyon tanulságos gondolatokat kitalálni és azt megosztani Veletek, de ilyenkor sosem jönnek azok a gondolatok.

Rengeteg emléket kaptam ettől a sporttól és Tőletek, akik olvassátok ezeket a sorokat, azoktól, akikkel 20 éve szervezzük a HunGarian Baját és azoktól, akik csak egy-egy alkalommal vettek részt. Mindenre és mindenkire emlékszem! A neveiteket fel is írtam pár helyre...Ti is megnézhetitek! A 20 év minden napja mintha tegnap lett volna. Óriási sportsikerek születtek és volt, hogy a legjobb tudásunk és akaratunk mellett is csak a szerencse mentette meg a rendezvényt. Volt többször is, hogy el kellett költöznünk a versennyel és így együtt járhattuk be ezt a csodálatosan szép országot Veletek.



Nagyon szerencsésnek mondhatom magam, hiszen gyerekkorom óta csak játszom és azzal foglalkozhatom ami számomra a legjobb munka, a legszebb és legösszetettebb játék.

21 éve azért költöztem Veszprémbe a Fővárosból, mert szerelmes lettem a lőtér végeláthatatlan hullámaiba, a Bakonyba, a Balatonba és az egész környékbe. Tudtam, hogy itt találom meg az Otthonom, a Családom és itt tudom megvalósítani minden álmom. Így is lett!

Olykor bolond és konok vagyok. Nincs más út, csak az enyém. Ez az egyik dolog, amiért el tudunk jutni egy ilyen jubileumi évszámhoz, amit én is csak ízlelgetni tudok, mert a kezdetekkor még az is egy, a valóságtól alaposan elrugaszkodott álomnak tűnt, hogy egyszer majd a HunGarian Baja három vagy netán öt éves lesz. Hát, most a XX. lett...

Van viszont egy másik és talán a legfontosabb csoda az életemben, akiknek mind hálával tartozunk. Ők a Családom!

A feleségem Eszter, a nagyobb fiam Olivér és a kisfiam Martin. Köszönöm Nektek, hogy szeretitek és elviselitek ezt a bolondot!

Minden egyebet olvassatok el a versenykiírásokról és a sajtóanyagokról!

**BALESETMENTES, BOLDOG SZÜLETÉSNAPI HUNGARIAN BAJÁT KÍVÁNOK!**

Garamvölgyi Zoltán  
Rendező



## INTRODUCTION

3

## BEVEZETÉS

“Hungarian Baja 2023”

is organized by Garilla Racing Kft. and GARZONE s.r.o.

10-12. August 2023.

### TITLES FOR WHICH HUNGARIAN BAJA 2022 COUNTS:

- 3<sup>rd</sup> Round of the FIA European Cup for Cross-Country Bajas 2023
- 5<sup>th</sup> Round of FIA CEZ Cross-Country Baja Championship
- 3<sup>th</sup> Hungarian Cross-Country Championship, with coefficient two.
- 5<sup>th</sup> Round of the FIM Bajas World Cup 2023.
- 3<sup>th</sup> MAMS International Open Baja Cup, with International Participants

## PAST WINNERS

4

## ELŐZŐ NYERTESEK

### AUTÓ / CARS

YEAR	NAMES	VEHICLE	NAT.
2004	1° GÁL ISTVÁN – OROZSLÁN TIBOR	G-BABA PROTO 5	HUN
	2° KIS SÁNDOR – CZEGLÉDI PÉTER	NISSAN PICK UP	HUN
	3° LISZI LÁSZLÓ – RACK GYÖRGY	NISSAN PICK UP	HUN
2005	1° SAUKANS MARIS – DZENIS ULDIS	OSCAR	LTV
	2° KIS SÁNDOR – CZEGLÉDI PÉTER	NISSAN PICK UP	HUN
	3° SYKORA JOZEF – SYKORA MAREK	NISSAN PICK UP	SVK
2006	1° KIS SÁNDOR – CZEGLÉDI PÉTER	NISSAN PICK UP	HUN
	2° ZAPLETAL MIROSLAV – JANACEK MILOSLAV	MITSUBISHI PAJERO	CZE
	3° GÁL ISTVÁN – OROZSLÁN TIBOR	G-BABA PROTO 5	HUN
2007	1° ZAPLETAL MIROSLAV – JANACEK MILOSLAV	MITSUBISHI STRAKAR	CZE (H)
	2° KIS SÁNDOR – CZEGLÉDI PÉTER	NISSAN	HUN
	3° PALIK LÁSZLÓ – DARÁZSI GÁBOR	NISSAN PICK UP	HUN
2008	1° AL-ATTIYAH NASSER – THÖRNER TINA	BMW X3 CC	QAT/SWE
	2° NOVITSKIY LEONID – TYUPENKIN OLEG	BMW X3 CC	RUS
	3° ZAPLETAL MIROSLAV – OUREDNICEK TOMAS	MITSUBISHI STRAKAR	CZE (H)
2009	1° VAN DEIJNE TONNIE – ROSEGAAR WOUTER	MITSUBISHI MPR13	NLD
	2° PALIK LÁSZLÓ – DARÁZSI GÁBOR	NISSAN NAVARA	HUN
	3° ZAPLETAL MIROSLAV – OUREDNICEK TOMAS	MITSUBISHI STRAKAR	CZE (H)
2010	1° GADASIN BORIS – SCHEMEL DAN	G-FORCE PROTO	RUS
	2° KORDA ERIK – TÓTH GYÖRGY	NISSAN PICK-UP	HUN
	3° SZALAY BALÁZS – BUNKÓCZI LÁSZLÓ	CHEVROLET BLAZER	HUN





2011	1° NOVITSKIY LEONID - SCHULZ ANDREAS 2° GADASIN BORIS - SHCHEMEL DAN 3° ZAPLETAL MIROSLAV - OUREDNICEK TOMAS	BMW X3CC G-FORCE PROTO BMW X3	RUS/GER RUS CZE
2012	1° GADASIN BORIS - KUZMICH ALEXEY 2° FAZEKAS KÁROLY - HORN ALBERT 3° ZAPLETAL MIROSLAV - MARTON MACIEJ	G-FORCE PROTO BMW X6 H3 EVO	RUS HUN CZE (H)
2013	1° ROMA JOAN - PERIN MICHEL 2° HOLOWCZYC KRZYSZTOF - SCHULZ ANDREAS 3° COFFARO NUNZIO - MENESES DANIEL	MINI ALL4 RACING MINI ALL 4 RACING TOYOTA OVERDRIVE	ESP/FRA POL/GER VEN
2014	1° AL-ATTIYAH NASSER - BAUMEL MATTHIEW 2° VASILYEV VLADIMIR - ZHILTSOV KONSTANTIN 3° TERRANOVA ORLANDO - GRAUE BERNARDO	TOYOTA OVERDRIVE MINI ALL4 RACING MINI ALL 4 RACING	QAT/FRA RUS ARG
2015	1° AL-ATTIYAH NASSER - BAUMEL MATTHIEW 2° TEN BRINKE BERNHARD - COLSOUL TOM 3° ZAPLETAL MIROSLAV - MARTON MACIEJ	MINI ALL4 RACING TOYOTA HILUX OVERDRIVE H3 EVO VII	QAT/FRA NED/BEL CZE/POL
2016	1° HIRVONEN MIKKO - PERIN MICHEL 2° MENZIES BRYCE - MORTENSEN PETE 3° ZAPLETAL MIROSLAV - MOMOT BARTOSZ	MINI ALL4 RACING MINI ALL4 RACING H3 EVO VII	FIN/FRA USA/USA CZE/POL
2017	1° AL-ATTIYAH NASSER - BAUMEL MATTHIEW 2° HIRVONEN MIKKO - SCHULZ ANDREAS 3° PRZYGONSKI JAKUB - COLSOUL TOM	TOYOTA HILUX OVERDRIVE MINI JOHN COOPER WORKS RALLY MINI JOHN COOPER WORKS RALLY	QAT/FRA FIN/GER POL/BEL
2018	1° ROMA JOAN CARARACH - HARO BRAVO ALEX 2° PRZYGONSKI JAKUB - COLSOUL TOM 3° VASILYEV VLADIMIR - ZHILTSOV KONSTAN TIN	MINI JOHN COOPER WORKS RALLY MINI JOHN COOPER WORKS RALLY TOYOTA HILUX OVERDRIVE	ESP/ESP POL/BEL RUS/RUS
2019	1° TERRANOVA ORLANDO - GRAUE BERNARDO ROLANDO 2° PROKOP MARTIN - TOMÁNEK JAN 3° VASILYEV VLADIMIR - ZHILTSOV KONSTANTIN	MINI JOHN COOPER WORKS RALLY FORD RAPTOR RS CROSSCOUNTRY TOYOTA HILUX	ARG/ARG CZE/CZE RUS/RUS
2021	1° HOLOWCZYC KRZYSZTOF - KURZEJA LUKASZ 2° AL RAJHI JAZEED - ORR MICHAEL 3° SEAIDAN YASIR - KUZMICH ALEXEI	MINI JOHN COOPER WORKS RALLY TOYOTA HILUX OVERDRIVE MINI JOHN COOPER WORKS RALLY	POL/POL SAU/GBR SAU/RUS
2022	1° VANAGAS BENEDICTAS - SIKK KULDAR 2° MALUSZYNSKI MICHAL - KURZEJA LUKASZ 3° FERREIRA JOAO - MONTEIRO DAVID	TOYOTA HYLUX MINI JOHN COOPER WORKS RALLY MINI JOHN COOPER WORKS RALLY	LTU/EST POL/POL POR/POR

## MOTOR / QUAD

YEAR	NAMES	VEHICLE	NAT.
2006	BIKE 1° KATRINAK JAROSLAV	KTM 450 EXC	SVK
	QUAD 1° SEGATO DARIO	SUZUKI LTR 450	ITA
2007	BIKE 1° JAKES IVAN	KTM 450	SVK
	QUAD 1° NÉMETH NORBERT	YAMAHA YFZ 450	HUN
2008	BIKE 1° KATRINAK JAROSLAV	KTM 530 EXC R	SVK
	QUAD 1° MACHACEK JOSEF	YAMAHA 850	CZE
2009	BIKE 1° MEGRE DAVID	KTM 250 EXC	POR
	QUAD 1° CRUZ PAULINO	SUZUKI LTR 450	POR
2010	BIKE 1° CECI PAOLO	BETA RR 450	ITA
	QUAD 1° MACHACEK JOSEF	YAMAHA RAPTOR	CZE



2011	BIKE 1° BRUNOD ANDREA	HUSQVARNA TE449	ITA
	QUAD 1° LASKAWIEC LUKASZ	YAMAHA RAPTOR	POL
2012	BIKE 1° CASTEU DAVID	YAMAHA 450	FRA
	QUAD 1° BRUSSELSERS ALEX	E-ATV	NED
2013	BIKE 1° ZANOTTI ALEX	TM BAJA 530 R	RSM
	QUAD 1° WISNIEWSKI KAMIL	YAMAHA RAPTOR 700	POL
2014	BIKE 1° VOJKUVKA LUBOMIR	BETA RR 450	CZE
	QUAD 1° WISNIEWSKI KAMIL	YAMAHA RAPTOR 700	POL
2015	BIKE 1° MARÉ ADRIEN	KTM 450 EXC	FRA
	QUAD 1° RAJCIK DAMIAN	YAMAHA YFZ	POL
2016	BIKE 1° DE SOULTRAIT XAVIER	YAMAHA WRF 450	FRA
	QUAD 1° VENTURA AMERIGO	YAMAHA QDY450R	ITA
2017	BIKE 1° SVITKO STEFAN	KTM 450 XC-F	SVK
	QUAD 1° MARTINS ARNALDO	SUZUKI LTR 450	POR
2018	BIKE 1° SVITKO STEFAN	KTM RALLY	SVK
	QUAD 1° MARTINS ARNALDO	SUZUKI LTR 450	POR
2019	BIKE 1° TOMICZEK ADAM	HUSQVARNA 450 FE	POL
	QUAD 1° VARGA JURAJ	YAMAHA YFM 700R	SVK
2021	BIKE 1° BÜHLER SEBASTIAN	HERO 450 RALLY	GER
	QUAD 1° VARGA JURAJ	YAMAHA YFM 700R	SVK
2022	BIKE 1° MULEC TONI	KTM HUSQVARNA 450 FE	SLO
	QUAD 1° VARGA JURAJ	YAMAHA YFM 700R	SVK

## RALLYPLATES / RALLYTÁBLÁK

<p>2004</p>	<p>2005</p>	<p>2006</p>	<p>2007</p>
<p>2008</p>	<p>2009</p>	<p>2010</p>	<p>2011</p>
<p>2012</p>	<p>2013</p>	<p>2014</p>	<p>2015</p>





2016 	2017 	2018 	2019 
2021 	2022 	2023 	

CONTACT DETAILS

5

ELÉRHETŐSÉGEK

## ORGANIZER'S CONTACT DETAILS / SZERVEZŐ ELÉRHETŐSÉGE

Házgyári str.1, 8200 Veszprém, Hungary

+36/30/696 0386

[info@hungarianbaja.com](mailto:info@hungarianbaja.com)

[www.hungarianbaja.com](http://www.hungarianbaja.com)

## LOCATION OF RALLY OFFICE, HQ / VERSENYIRODA CÍME, HQ

Thury Castle, Hunyadi Mátyás square 1., 8100 Várpalota, Hungary

+36/30/791 4270

## CREW RELATIONS OFFICER / VERSENYZŐI ÖSSZEKÖTŐ

Mr. István MÁTRAI

+36/20/417 6249

## PRESS OFFICE / SAJTÓIRODA

Ms. Anita TÓTH

+36/30/6960582

Accreditation: <http://www.hungarianbaja.com/en/media/>

Location: Thury Castle, Hunyadi Mátyás square 1., 8100 Várpalota, Hungary



## DIGITAL NOTICE BOARD / DIGITÁLIS HÍRDETŐTÁBLA

Digital Notice Board (DNB): Sportity, [www.hungarianbaja.com](http://www.hungarianbaja.com), [www.chromomoto.hu](http://www.chromomoto.hu)

CAR / AUTÓ :



M/Q:



On PC:

FIA : [https://webapp.sportity.com/channel/HGB23\\_FIA](https://webapp.sportity.com/channel/HGB23_FIA)

FIM : [https://webapp.sportity.com/channel/HGB23\\_FIM](https://webapp.sportity.com/channel/HGB23_FIM)

MNASZ : [https://webapp.sportity.com/channel/HGB23\\_TROB](https://webapp.sportity.com/channel/HGB23_TROB)

MAMS : [https://webapp.sportity.com/channel/HGB23\\_MAMS](https://webapp.sportity.com/channel/HGB23_MAMS)

OFFICIAL LOCATION

6

HELYSZÍNEK S

REGISTRATION	TESCO parking lot 8100 Várpalota, Fehérvári str. 17.	N47°12'00 E18°09'08
SERVICE PARC CAR	TESCO (grass surface) 8100. Várpalota, Fehérvári str. 17.	N47°12'00 E18°09'08



SERVICE PARC M/Q	GÁL GYULA SPORS HALL parking lot 8100. Várpalota, Fehérvári str. 9.	N 47°11'59.4132" E 18°8'48.7926"
RALLY OFFICE HQ	THURY CASTLE 8100. Várpalota, Hunyadi Mátyás Square 1.	N47°12'05" E18°08'20"
SCRUTINEERING	TESCO 8100. Várpalota, Fehérvári str. 17..	N47°12'00" E18°09'08"
PARC FERMÉ	VÁRPALOTA FŐTÉR 8100. Várpalota, Szabadság Square	N47°11'58" E18°08'26"

## PROGRAMME

7

## PROGRAM

### BEFORE THE EVENT / VERSENY ELŐTT

Date:	Time:		Location:
01.06.2023	10:00	Publishing of the supplementary regulations	
01.06.2023	10:00	Entries open	<a href="http://www.hungarianbaja.com">www.hungarianbaja.com</a>
01.06.2023	16:00	Issuing of Rally Guide	
10.07.2023	24:00	Closure date of entries at reduced fees	<a href="http://www.hungarianbaja.com">www.hungarianbaja.com</a>
27.07.2023	24:00	Closure date of entries	
27.07.2023	24:00	Closing date for order of extra service in SP	info@hungarianbaja.com
27.07.2023	24:00	Closing date for shakedown registration	
02.08.2023	16:00	Publication date of entry list	Sportity, <a href="http://www.hungarianbaja.com">www.hungarianbaja.com</a>
02.08.2023	10:00	Press conference before the rally	Thury Castle, Várpalota

### DURING THE EVENT / VERSENY ALATT

Minden csapatnak **Regisztrálni** kell a Szervizparkba állás előtt, ahol a Checklista és a Szerviztáblák kerülnek kiadásra. / All Teams have to **Register** before to go to the Service Park, where the Checklist and Service Plates will be provided. Cím / Address: Tesco parking lot, Fehérvári str. 17.

Date:	Time:		Location:
09.08.2023	16:00-20:00	Registration, Check List and Service Plate delivery	TESCO, Várpalota
10.08.2023	07:00-18:00	Registration, Check List and Service Plate delivery	TESCO, Várpalota
10.08.2023	08:00-15:00	Administrative checks	Thury Castle, Várpalota
10.08.2023	08:00	Collection of material and documents	Thury Castle, Várpalota
10.08.2023	08:00	Collection of rally safety tracking system	Thury Castle, Várpalota
10.08.2023	08:00	Collection of navigation GPS (NAV-GPS)	Thury Castle, Várpalota
10.08.2023	08:00-16:00	Scrutineering – sealing & marking of components	TESCO, Várpalota
10.08.2023	08:00	Opening of media centre	Thury Castle, Várpalota
10.08.2023	17:00-18:00	Re-scrutineering for car which did not pass	TESCO, Várpalota
10.08.2023	11:00-14:00	Shakedown	
10.08.2023	18:00	Team managers and/or Drivers' briefing	Thury Castle, Várpalota





10.08.2023	18:00	Issuing of the road book (Stage 1), maps	
10.08.2023	19:00	Publication of start list for Ceremonial Start	DNB
10.08.2023	19:00	Publication of list of cars eligible to start	DNB
10.08.2023	19:00	Publication of start list for Stage 1	DNB
10.08.2023	20:00	Ceremonial Start	Thury Castle, Várpalota
11.08.2023	08:00	Start of the Rally – Stage 1, Section 1 (TC0) Prologue	Thury Castle, Várpalota
11.08.2023	09:18	Finish of Section 1 (estimated time of 1 <sup>st</sup> car)	Thury Castle, Várpalota
11.08.2023	11:00	Selection of Starting Position after Prologue	Thury Castle, Várpalota
11.08.2023	11:30	Publication of start list for Stage 1, Section 2	DNB
11.08.2023	11:30- 12:00	Re-scrutineering, cars to re-start after retirement	TESCO, Várpalota
11.08.2023	12:00	Start of Stage 1, Section 2 (estimated time of 1 <sup>st</sup> car)	Thury Castle, Várpalota
11.08.2023	20:13	Finish of Stage 1 (estimated time of 1 <sup>st</sup> car)	
11.08.2023	22:30	Publication of start list for Stage 2	DNB
12.08.2023	09:00	Re-scrutineering, cars to re-start after retirement	TESCO, Várpalota
12.08.2023	10:00	Start Stage 2 (estimated time of 1 <sup>st</sup> car)	Thury Castle, Várpalota
12.08.2023	17:13	Finish of Stage 2 (estimated time of 1 <sup>st</sup> car)	Thury Castle, Várpalota
12.08.2023	17:30	Final scrutineering; Immediate after arrival in the finish (following the marshals' instructions)	MÁRIA GUMI, Várpalota
12.08.2023	18:30	Publication of Provisional Classification	DNB
12.08.2023	19:00	Publication of Final Classification; After the Stewards have declared the Classification final.	DNB
12.08.2023	19:00	Podiums Ceremony / Prize-giving	Thury Castle, Várpalota

## SHAKEDOWN

8

## TESZT

01. 06. 2023. Thursday

Opening date for shakedown's entries

27. 07. 2023. Monday

Closing date for shakedown's entries

10. 08. 2023 Thursday 08.00-13.00 Delivery Shakedown's materials (Identification plates – Road Book

10.08. 2023. Thursday 11:00- 14:00 Shakedown

Length: 4km

Fee:200€

## USEFUL FACTS

9

## FONTOS TUDNIVALÓK

### IMPORT OF VEHICLES AND SPARE PARTS:

Competitors from the European Union must NOT carry out any customs clearance for the temporary importation of cars, motorcycles and equipment in order to participate in the Hungarian Baja 2023.

Vehicles outside the European Union must bring their vehicles to customs for the temporary importation of cars, motorcycles and equipment.

### TIMEZONE IN HUNGARY / IDŐZÓNA:

GMT +2



#### LANGUAGE / NYELV:

Hungarian, but many speak english and german.

#### MONEY / PÉNZ:

The national currency is Hungarian Forint (Ft). Money exchange services are available at banks and specialized money exchange enterprises. It is safe to change money in any of this places, exchanging rate might differ from one place to other.

#### ELECTRICITY / ELEKTROMOSSÁG:

220 V European standard.

#### WATER / VÍZ:

Tap water is safe to odrink in this region.

#### MOBILE PHONES / MOBIL TELEFON:

You can buy SIM cards of the 4 leading mobile providers: Telekom, Vodafone, Yettel, DIGIMobil. At purchase you will be asked to present your passport. Mostly, you will be offered a monthly tariff that includes not only phone calls and SMS but 1-5 Gigabites of internet traffic. The cost will vary, depending on the options you choose.

#### EMERGENCY SERVICES / SÜRGŐSSÉGI ELLÁTÁS:



#### TRANSPORTATION / KÖZLEKEDÉS:

The closest airport to the race's venue is Budapest-119km, and Vienna-176km. You can take a Taxi from the airport or rent a car. Taxis in Budapest are expensive and unreliable.

#### TRAFFIC RULES / KÖZLEKEDÉSI SZABÁLYOK:

In Hungary you drive on the right side of the road.

- Urban Centers:50km/h;
- Extra-urban roads:90km/h;
- Highway:130km/h;
- Exceptions are indicated by means of road signs;
- In Hungary Blood Alcohol Content (BAC) Drink Driving Limit is 0.0.
- It is mandatory to wear safety belts in both the front and rear seats;
- It is mandatory to have on board the vehicle all the documents of the driver and of the vehicle itself (driving, license, insurance, registration certificate);



- When in the car, all passengers and the driver should be buckled up.
- Speaking on the phone while driving is only permitted with hands-free devices, or it will be fined by the road police.

#### ACCOMODATION / SZÁLLÁS:

[www.booking.com](http://www.booking.com)

[www.szallas.hu](http://www.szallas.hu)

[www.trivago.hu](http://www.trivago.hu)

HunGarian Baja: 20 years and  
20 different routes

10

HunGarian Baja: 20 év, 20  
különböző útvonal

Twenty years and twenty different routes - HunGarian Baja to be held from 10-12 August is promising a special anniversary edition at the well-known shooting range, and with a headquarter in Várpalota, namely the Thury Castle.

Zoltán Garamvölgyi, chief organizer promises a shorter, but compact, intense and high-level race, and he expects that, as always, HunGarian Baja would not be easy to win. The race will count as a round to Baja Europe Cup in the car category and FIM World Cup in bike category.

The distance of the special stages is over 460 km, and the etap stages are again racer-friendly. The rally guide includes an administrative check and scrutineering, a shake down on Thursday, and later in the evening the official starting ceremony, with a spectacular show starring the Squirrel (Mókus), a world, European and multiple Hungarian champion streetfighter.

The Prologue will take place on Friday morning on Tési Hill north of Várpalota, and after which the competitors will line up in the regrouping, and hold the start position choosing ceremony. The peloton then will complete two 110-km special stages, followed by two 123-km stages on the next day.

“The race will take place at the shooting range, with some familiar and certainly some unfamiliar parts. All in all, I expect the race to be spectacular, exciting and twisted” said Zoltán Garamvölgyi, chief organizer of HunGarian Baja. “The race had different routes every year so far, and we keep this good habit. However, what remains the same is the hospitality of Várpalota. The leaders and the residents of the city are looking forward to seeing us, and we try to reward it with a giant screen, additional programmes and a Street Festival after the fantastic prize giving ceremony of the 20<sup>th</sup> Anniversary HunGarian Baja. Certainly, the focus will be on the race throughout. I expect a strong field either in both the car and bike categories, with competitors expected to come from many European countries, from Africa and the Middle-East. Last year the only negative feedback was that there was some idle, so we changed the programme, and I can say that this year’s HunGarian Baja will be tough and intense.”

The chief organizer also revealed that the spectators’ points will be set up to give the public the chance to get a taste of the real cross-country rally, while others could follow the race live on the LED screens at the main





square. Not to mention that the regrouping will be set up at the main square, which means that fans will be able to see the drivers and vehicles up close in the city centre.

Húsz év, húsz különböző útvonal – az augusztus 10-12. között rendezendő HunGarian Baja különleges jubileumot ígér, amely a versenyzők által már jól ismert lőtéren zajlik majd, a központja pedig ezúttal is Várpalota lesz, közelebből a Thury-vár.

A korábbiaknál egy nappal rövidebb, ugyanakkor kompakt, pörgős és színvonalas versenyt ígér Garamvölgyi Zoltán főszervező, no meg azt, hogy ezúttal sem lesz könnyű dolga annak, aki meg akarja nyerni a HunGarian Baját, amely az autósoknál a Baja Európa-kupa, a motorosoknál a FIM világcupa értékelésébe számít bele.

A szelektív szakaszok hossza meghaladja a 460 kilométert, az összekötő szakaszok kialakítása pedig ezúttal is „versenyző-barát”. A versenykiírásból kiderül: csütörtökön lezajlik az adminisztratív és a technikai gépátvétel, valamint a shake down, este pedig sor kerül a Thury-vár előtti ünnepélyes rajtceremóniára – látványos show keretében, amelynek egyik főszereplője a világ-, Európa- és sokszoros magyar bajnok motoros streetfighter, Mókus lesz.

A prologot péntek reggel rendezik a Várpalotától északra eső Tési-dombon, ezután a versenyzők beállnak a vár előtti gyűjtőállomásra, és megtartják a rajthelyválasztót. Ezt követően két 110 kilométeres szelektív szakaszt teljesít a mezőny, míg másnap két 123 kilométeres pálya szerepel a programban.

„A lőtéren zajlanak majd a küzdelmek, lesznek a pályának ismerős részei, és persze ismeretlenek is – összességében látványos, izgalmas, változatos versenyre számítok – nyilatkozta Garamvölgyi Zoltán, a HunGarian Baja főszervezője. – Eddig minden évben más útvonalon haladt a mezőny, ezt a jó szokásunkat most is megtartjuk, ami viszont változatlan, az Várpalota vendégszeretete. A város vezetősége és lakói nagyon várnak minket, mi pedig ezt óriás-kivetítővel, kiegészítő programokkal, és a nagyszabású díjkiosztó után a XX. jubileumi HunGarian Baja utcabállal igyekszünk meghálálni a főtéren. Persze a fókuszban végig a verseny lesz: erős mezőnyre számítok mind az autós, mind a motoros kategóriában – vélhetően Európa sok országából, Afrikából- és a közel-keleti arab világból is jönnek majd versenyzők. Tavaly az volt az egyetlen nemzetközi kritika, hogy néha akadtak üresjáratok – emiatt átvariáltuk a programot, úgyhogy nehéz, pörgős verseny lesz az idei HunGarian Baja.”

A főszervező elárulta még, hogy a nézői pontokat úgy alakítják majd ki, hogy az érdeklődők belekóstoljanak a tereprali sava-borsába, a fentebb említett, főtéren elhelyezett LED-falon pedig az is élőben követheti az eseményeket, aki esetleg a pályákra nem jut ki. Arról nem beszélve, hogy a főtéren alakítják ki a gyűjtőállomást is, ami azt jelenti, hogy a belvárosban testközelből láthatják a szurkolók a versenyzőket és a járműveket is.



## ITINERARY / CAR

11

## IDŐTERV / AUTÓ



## XX. HUNGARIAN BAJA

CAR

Stage 1		2022.08.11. FRIDAY / PÉNTEK						
Sunrise	5:29						20:17	Sunset
IE/TC	Location	SS Maximum Time	SS Km	Liasion Km	Total Km	Target Time	1st vehicle Due	
TC0A	VÁRPALOTA Parc Ferme OUT						8:00	
TC0B	Várpalota			3,33	3,33	0:10	8:10	
DSS P	PROLOGUE START					0:05	8:15	
ASS P	PROLOGUE FINISH	0:30	9,47		12,80	( 0:08 )	( 8:23 )	
Várpalota <i>Refueling, Petrol Station,</i>								
TC0C	Service IN (FIA Tire marking)			6,73	19,53	0:20	8:43	
SERVICE A								
TC0D	Service OUT (FIA Tire marking)			0,83	20,36	0:30	9:13	
TC0E	Regrouping IN			0,51	20,87	0:05	9:18	
REGROUPING / START POSITION CHOOSING for LEG1 Section 2 - ONLY for the TOP 10 on Podium (Sportivity)							11:00	
TC0F	Regrouping OUT						12:00	
TC1	Várpalota			2,76	23,63	0:10	12:10	
DSS 1A	START					0:05	12:15	
ASS 1A	FINISH	1:30	52,67		76,30	( 0:42 )	( 12:57 )	
Gyulafrátót <i>Neutralization zone</i>								
	Gyulafrátót			1,38	77,68	0:15	13:12	
DSS 1B	START						13:12	
ASS 1B	FINISH	1:30	57,99		135,67	( 0:46 )	( 13:58 )	
Újmajor <i>Refueling, Petrol Station,</i>								
TC1A	Service IN (FIA Tire marking)			31,50	167,17	0:50	14:48	
SERVICE / SZERVIZ B								
TC1B	Service OUT (FIA Tire marking)			0,83	168,00	0:40	15:28	
TC1C	Regrouping IN			0,51	168,51	0:05	15:33	
REGROUPING								
TC1D	Regrouping OUT						16:00	
TC2	Várpalota			2,76	171,27	0:10	16:10	
DSS 2A	START					0:05	16:15	
ASS 2A	FINISH	1:30	52,67		223,94	( 0:42 )	( 16:57 )	
Gyulafrátót <i>Neutralization zone</i>								
	Gyulafrátót			1,38	225,32	0:15	17:12	
DSS 2B	START						17:12	
ASS 2B	FINISH	1:30	57,99		283,31	( 0:46 )	( 17:58 )	
Újmajor <i>Refueling, Petrol Station,</i>								
TC2A	Service IN (FIA Tire marking)			31,50	314,81	0:50	18:48	
SERVICE / SZERVIZ C								
TC2B	Service OUT (FIA Tire marking)			0,83	315,64	1:20	20:08	
TC2C	Parc Ferme IN / Early Check-IN is Authorised			0,51	316,15	0:05	20:13	
Day Total			221,32	85,36	316,15			
			70,00%	27,00%	100%			



# XX. HUNGARIAN BAJA

## CAR

Stage 2		2022.08.12. SATURDAY / SZOMBAT						
Sunrise	5:30						20:15	Sunset
IE/TC	Location	SS Maximum Time	SS Km	Liasion Km	Total Km	Target Time	1st vehicle Due	
TC1F	Parc Fermé OUT						10:00	
TC3	Újmajor			29,81	29,81	0:45	10:45	
DSS 3A	START					0:05	10:50	
ASS 3A	FINISH	1:30	58,30		88,11	( 0:47 )	( 11:37 )	
							(Expected time of arrival)	
Neutralization zone								
	Gyulafrátót			1,38	89,49	0:15	11:52	
DSS 3B	START						11:52	
ASS 3B	FINISH	1:40	64,50		153,99	( 0:51 )	( 12:43 )	
							(Expected time of arrival)	
Várpalota								
Refueling, Petrol Station,								
TC3A	Service IN (FIA Tire marking)			3,95	157,94	0:15	12:58	
SERVICE / SZERVIZ D								
TC3B	Service OUT (FIA Tire marking)			0,83	158,77	0:40	13:38	
TC3C	Regrouping IN			0,51	159,28	0:05	13:43	
REGROUPING								
TC3D	Regrouping OUT						14:15	
TC4	Újmajor			29,81	189,09	0:45	15:00	
DSS 4A	START					0:05	15:05	
ASS 4A	FINISH	1:30	58,30		247,39	( 0:47 )	( 15:52 )	
							(Expected time of arrival)	
Neutralization zone								
	Gyulafrátót			1,38	248,77	0:15	16:07	
DSS 4B	START						16:07	
ASS 4B	FINISH	1:40	64,50		313,27	( 0:51 )	( 16:58 )	
							(Expected time of arrival)	
Várpalota								
TC4A	Parc Ferme IN / Early Check-IN is Authorised			3,95	317,22	0:15	17:13	
Day Total			245,60	71,62	317,22			
			77,42%	22,58%	100%			

Section 4

Section 5

	SS km	Liasion km	Total km
Rally Total	466,92	156,98	633,37
	73,72%	24,78%	100%





## ITINERARY / M, Q

11

## IDŐTERV / M, Q



## XX. HUNGARIAN BAJA

MOTO

Stage 1								2022.08.11. FRIDAY / PÉNTEK	
Sunrise		5:29		20:17		Sunset			
IE/TC	Location	SS Maximum Time	SS Km	Liasion Km	Total Km	Target Time	1st vehicle Due		
TC0A	VÁRPALOTA Parc Ferme OUT						9:30	Section 1	
TC0B	Várpalota			3,33	3,33	0:10	9:40		
DSS P	PROLOGUE START					0:05	9:45		
ASS P	PROLOGUE FINISH	0:30	9,47		12,80	( 0:08 )	( 9:53 )		
	Várpalota						(Expected time of arrival)		
	Refueling, Petrol Station,								
TC0C	Service IN			6,73	19,53	0:15	10:08		
	SERVICE A								
TC0D	Service OUT			0,83	20,36	0:15	10:23		
TC0E	Regrouping IN			0,51	20,87	0:05	10:28		
	REGROUPING								
TC0F	Regrouping OUT						10:40	Section 2	
TC1	Várpalota			2,76	23,63	0:10	10:50		
DSS 1A	START					0:05	10:55		
ASS 1A	FINISH	1:30	52,67		76,30	( 0:42 )	( 11:37 )		
	Gyulafrátót						(Expected time of arrival)		
	Neutralization zone								
	Gyulafrátót			1,38	77,68	0:15	11:52		
DSS 1B	START						11:52		
ASS 1B	FINISH	1:30	57,99		135,67	( 0:46 )	( 12:38 )		
	Újmajor						(Expected time of arrival)		
	Refueling, Petrol Station,								
TC1A	Service IN			31,50	167,17	0:50	13:28		
	SERVICE / SZERVIZ B								
TC1B	Service OUT			0,83	168,00	0:30	13:58		
TC1C	Regrouping IN			0,51	168,51	0:05	14:03		
	REGROUPING								
TC1D	Regrouping OUT						14:30	Section 3	
TC2	Várpalota			2,76	171,27	0:10	14:40		
DSS 2A	START					0:05	14:45		
ASS 2A	FINISH	1:30	52,67		223,94	( 0:42 )	( 15:27 )		
	Gyulafrátót						(Expected time of arrival)		
	Neutralization zone								
	Gyulafrátót			1,38	225,32	0:15	15:42		
DSS 2B	START						15:42		
ASS 2B	FINISH	1:30	57,99		283,31	( 0:46 )	( 16:28 )		
	Újmajor						(Expected time of arrival)		
	Refueling, Petrol Station,								
TC2A	Service IN (FIA Tire marking)			31,50	314,81	0:50	17:18		
	SERVICE / SZERVIZ C								
TC2B	Service OUT			0,83	315,64	1:20	18:38		
TC2C	Parc Ferme IN / Early Check-IN is Authorised			0,51	316,15	0:05	18:43		
Day Total		221,32	85,36	316,15					
		70,00%	27,00%	100%					



# XX. HUNGARIAN BAJA

## MOTO

Stage 2								2022.08.12. SATURDAY / SZOMBAT	
Sunrise 5:30								20:15	Sunset
IE/TC	Location	SS Maximum Time	SS Km	Liasion Km	Total Km	Target Time	1st vehicle Due		
TC1F	Parc Fermé OUT						8:00		
TC3	Újmajor			29,81	29,81	0:45	8:45		
DSS 3A	START					0:05	8:50		
ASS 3A	FINISH	1:30	58,30		88,11	( 0:47 )	( 9:37 )		
						(Expected time of arrival)			
Neutralization zone									
				1,38	89,49	0:15	9:52		
DSS 3B	START						9:52		
ASS 3B	FINISH	1:40	64,50		153,99	( 0:51 )	( 10:43 )		
						(Expected time of arrival)			
Várpalota									
Refueling, Petrol Station,									
TC3A	Service IN			3,95	157,94	0:15	10:58		
SERVICE / SZERVIZ D									
TC3B	Service OUT			0,83	158,77	0:40	11:38		
TC3C	Regrouping IN			0,51	159,28	0:05	11:43		
REGROUPING									
TC3D	Regrouping OUT						12:15		
TC4	Újmajor			29,81	189,09	0:45	13:00		
DSS 4A	START					0:05	13:05		
ASS 4A	FINISH	1:30	58,30		247,39	( 0:47 )	( 13:52 )		
						(Expected time of arrival)			
Neutralization zone									
				1,38	248,77	0:15	14:07		
DSS 4B	START						14:07		
ASS 4B	FINISH	1:40	64,50		313,27	( 0:51 )	( 14:58 )		
						(Expected time of arrival)			
Várpalota									
TC4A	Parc Ferme IN / Early Check-IN is Authorised			3,95	317,22	0:15	15:13		
Day Total			245,60	71,62	317,22				
			77,42%	22,58%	100%				

Section 4

Section 5

	SS km	Liasion km	Total km
Rally Total	466,92	156,98	633,37
	73,72%	24,78%	100%

MAPS

12

TÉRKÉPEK

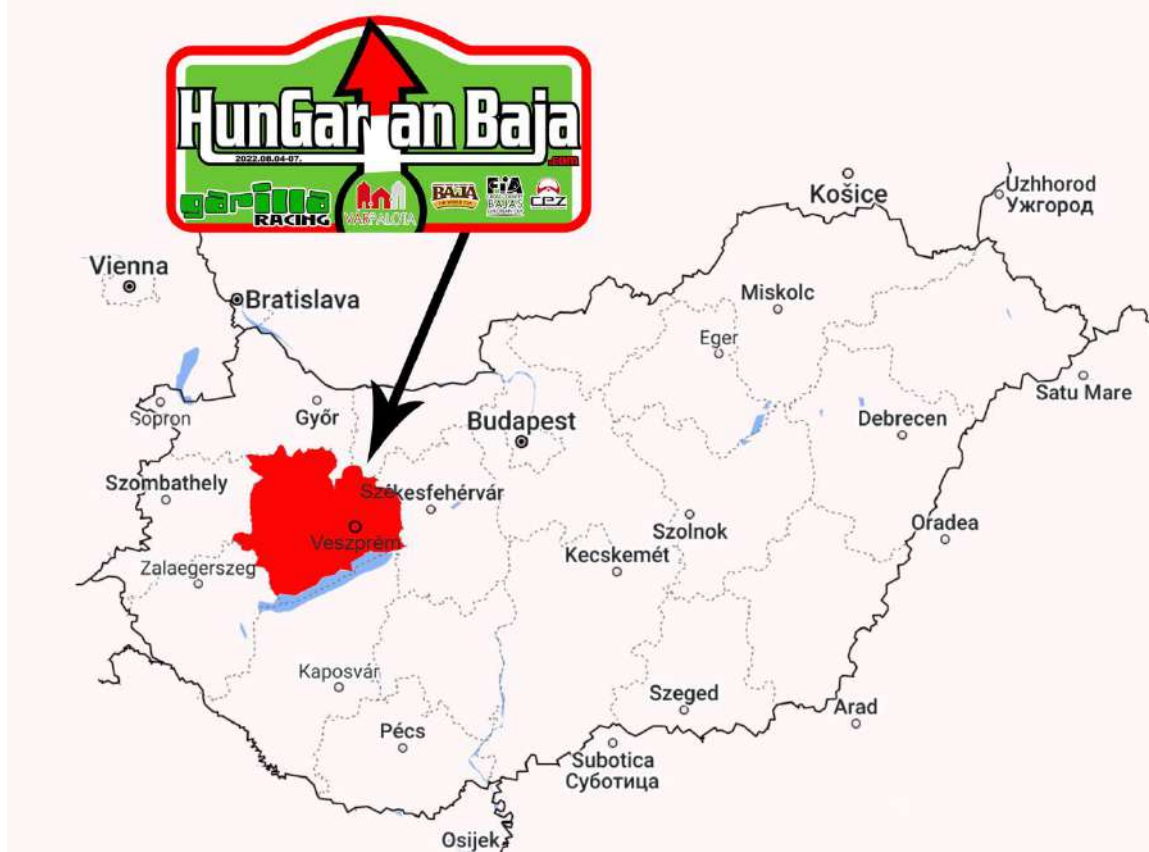

MAIN LOCATIONS / FŐBB HELYSZÍNEK  
VÁRPALOTA

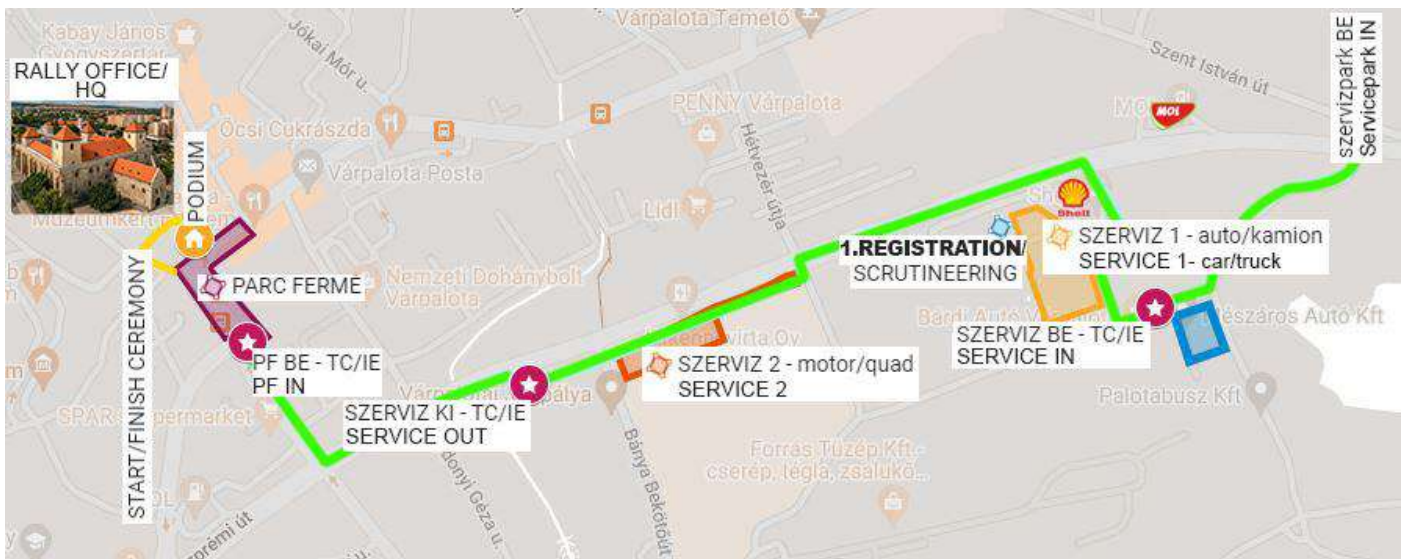





GPS

13

GPS



### MAIN SCREEN



Diagram illustrating the main screen layout with labels:

- CAP**: Points to the '95°' display.
- NUMBER OF THE TARGET WAYPOINT**: Points to 'K27S'.
- NAME OF THE TARGET WAYPOINT**: Points to '026'.
- TOTAL ODOMETER**: Points to '025.48'.

# WAYPOINT PROXIMITY



TARGET WAYPOINT DIRECTION

DISTANCE TO WAYPOINT

TOTAL ODOMETER

CAP

# SPEED ZONE



SPEED LIMIT

SPEED LIMIT

REAL SPEED

# REQUEST MEDICAL ATTENTION IMMEDIATELY



SOS

1 sec.



# CAUTION VEHICLE STATIONARY



3 sec. BREAKDOWN





# DANGER 3 !!!



Notification 300m before an area marked in the roadbook as "Danger 3"

# OVERTAKING / BLUE FLAG



# OVERTAKING / BLUE FLAG



STEADY



FLASHING



# OVERTAKING / BLUE FLAG



FREE TO OVERTAKE



STEADY

PRESS THE BLUE BUTTON TO CONFIRM

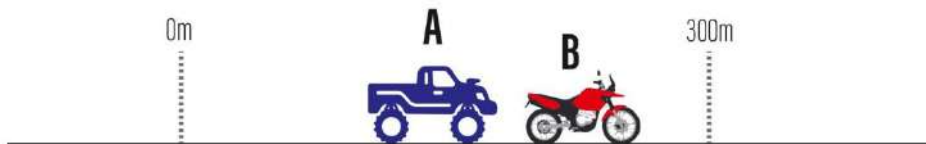

# SPEED LIMIT



# SPEED LIMIT

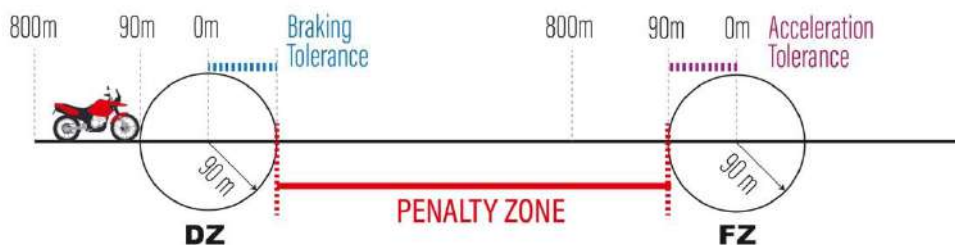



# SPEED LIMIT

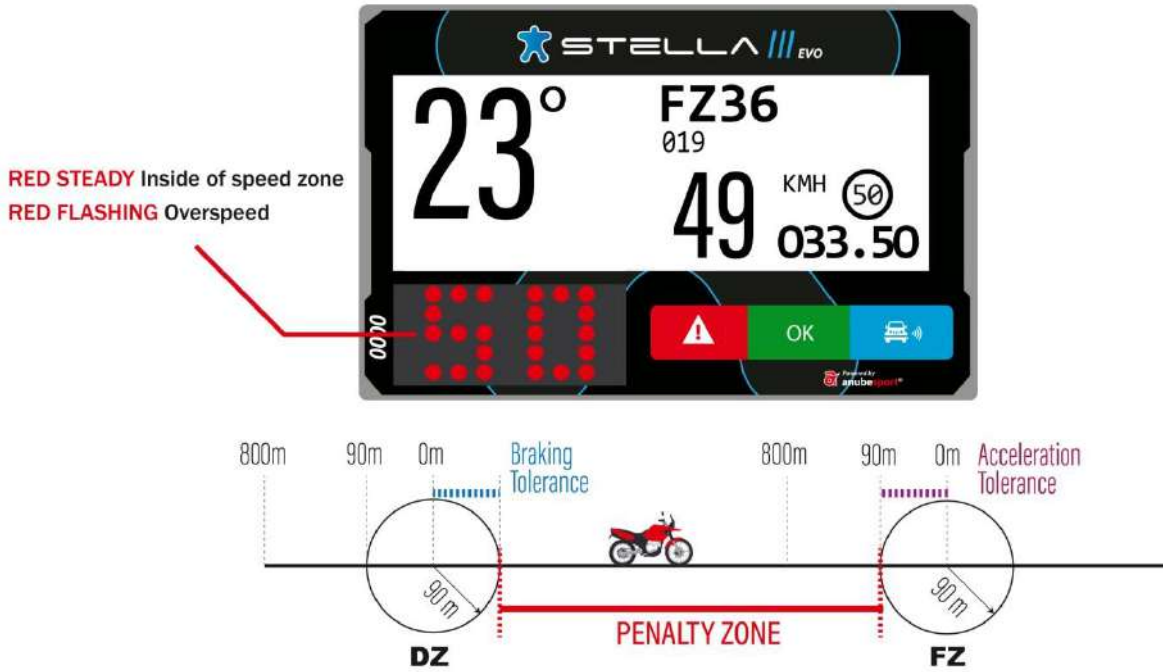

# SPEED LIMIT

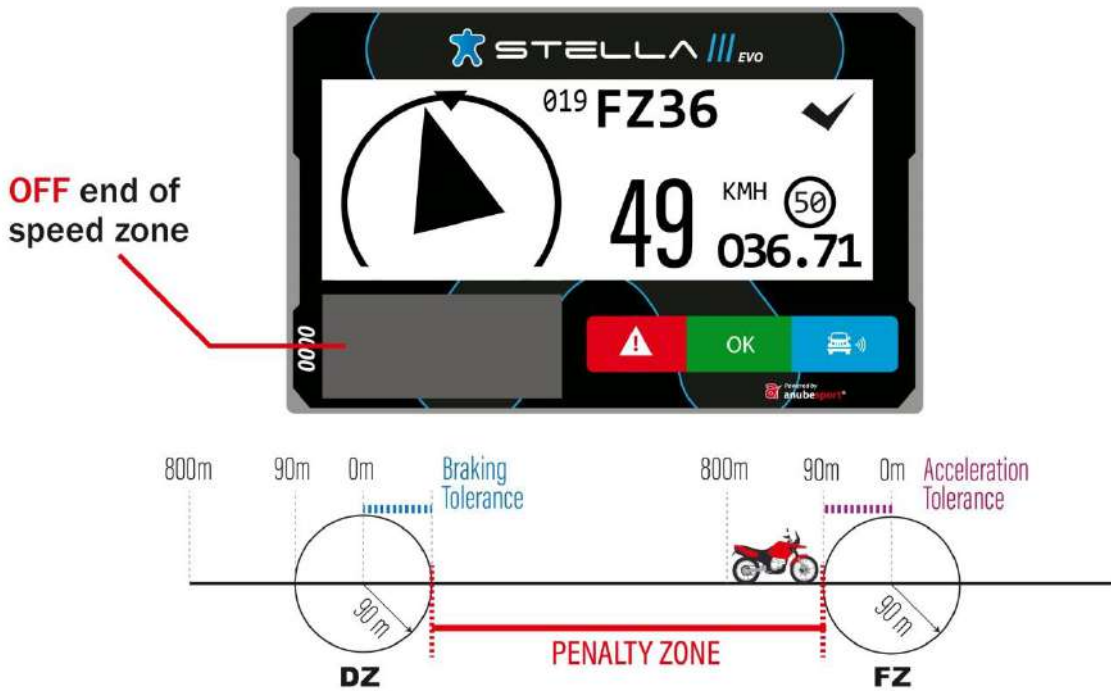

# NEUTRALIZATION ZONE

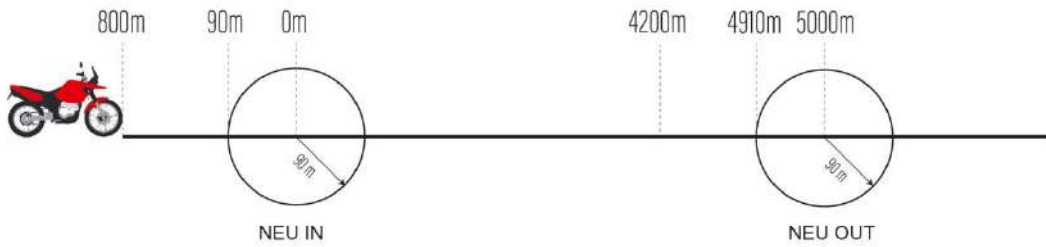

# NEUTRALIZATION ZONE

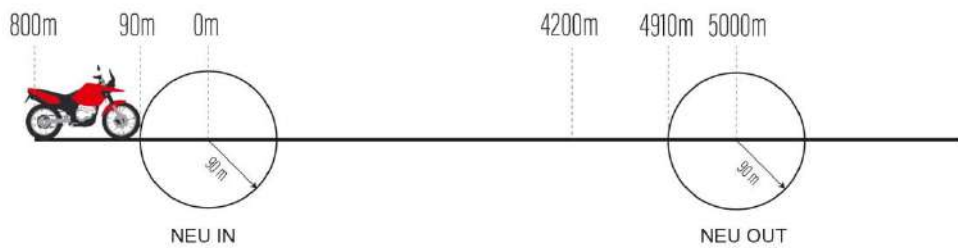



# NEUTRALIZATION ZONE

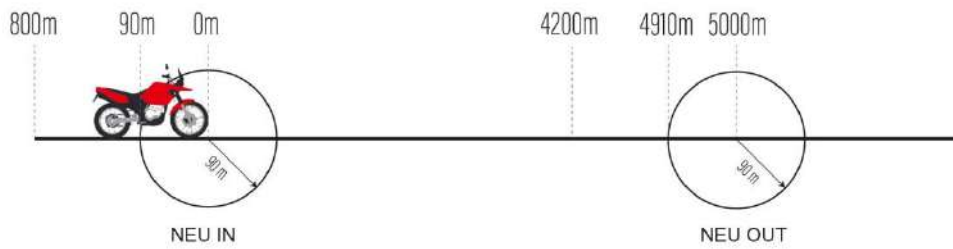

# NEUTRALIZATION ZONE

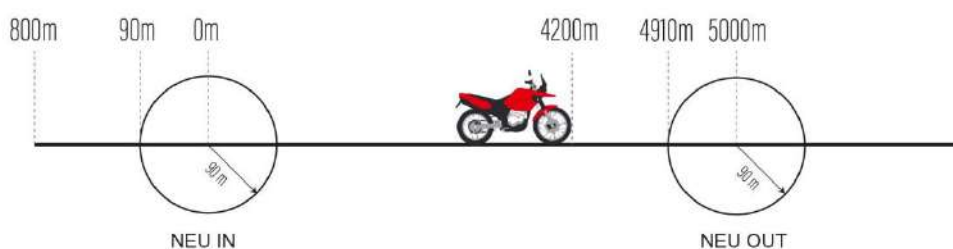



# NEUTRALIZATION ZONE

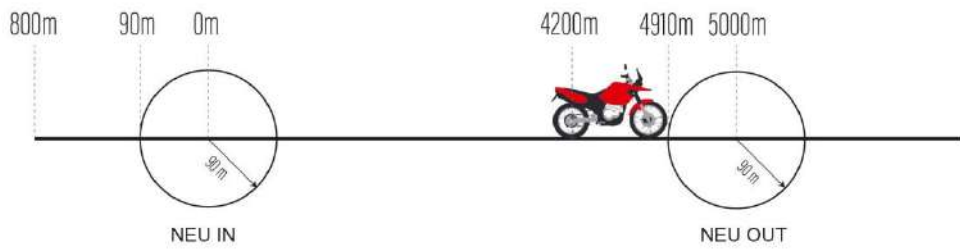

# NEUTRALIZATION ZONE

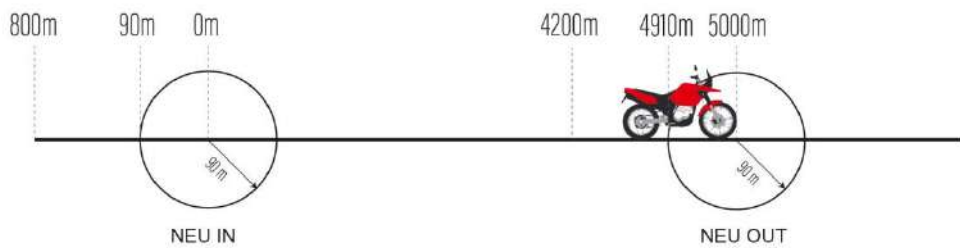



# MESSAGES



# WAYPOINTS LIST





# TOTAL ODOMETER RESET TO ZERO



OK



1 sec.

+



1 sec.

+



1 sec.

## GPS INSTALLATION KIT

12

## GPS BESZERELÉSI CSOMAG

**KIT COMPONENTS 80 €**



1. Iridium Antenna
2. Power Cord
3. RF Cord
4. RF Antenna
5. Base/Mount
6. GPS Antenna
7. Adhesive
8. Straps
9. User Manual

### IMPORTANT

For the functional tests and verification, all vehicles must have gone through the installation of the mount, power cord, and antennas.



## 1. POWER CORD

- Connect the red wire to the positive end of the battery 12V(+), and the grey wire to the negative end (GRD). The power cord must be connected directly to the battery (without interruptions and without contact in the power supply).
- A 3A fuse (not included) should be connected to the red wire.
- Take the cord to the location in which the STELLA III EVO is to be installed. All other wires must be insulated, they cannot touch.



## 2. BASE/MOUNT

- Motorcycles and ATV: The mount can be attached to the handle bar or to a metal plaque close to the navigation system.
- Cars and UTV: The mount can be attached to the panel, or to the roll cage bars. STELLA III EVO buttons must be visible and accessible to the participant (pilot/navigator) even when they are sitting and with the seatbelts buckled.

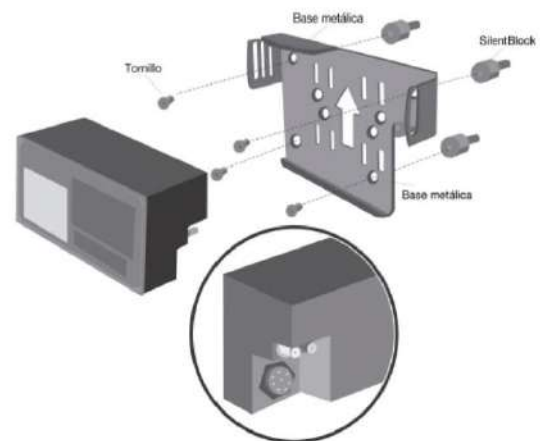

### IMPORTANT

Leave the cords (antenna and battery) in place with at least 10 cm to spare for easy handling.

At least 5 cm of space behind the mount (bottom right corner) to allow space for power cord/connections.

### 3. GPS ANTENNA

The GPS antenna must be installed horizontally and without obstructions toward the sky. In cars and UTV, It can be mounted on the roof, the hood, or the dashboard. In motorcycles and ATV, attach to the mudguard. For additional firmness, it is recommended to cover it with adhesive tape (non metallic when mounting it to a metallic surface) and pull-up (when attached to soft or plastic parts).



### 4. ANTENNA IRIDIUM

The Iridium antenna must be installed horizontally and without obstructions toward the sky. In cars and UTV, It can be mounted on the roof, the hood, or the dashboard. In motorcycles and ATV, attach to the mudguard. For additional firmness, it is recommended to cover it with adhesive tape (non metallic when mounting it to a metallic surface) and pull-up (when attached to soft or plastic parts).



### 5. RF ANTENNA

The radio-frequency antenna must be installed vertically to the roll cage bars (cars and UTV) and the forks (motorcycles and ATV). It is mandatory to use separators (included in the kit) to avoid contact with metallic parts and the carbon fibre that surrounds it.

Once the antennas are mounted, take the SMA connection cords to the base/mount where the STELLA III EVO will be installed.





KERESSE  
A PATIKÁKBAN!

ÚJ



BIOEXTRA

# OLIVA D<sub>3</sub> 3000 NE

ÉTREND-KIEGÉSZÍTŐ  
LÁGYZSELATIN  
KAPSZULA

Olívaolajban oldott  
D-vitamin  
az immunrendszer  
támogatásáért

  
BIOEXTRA

TÖRÖDÜNK AZ EGÉSZSÉGGEL

[www.bioextra.hu](http://www.bioextra.hu)

 MAGYAR GYÁRTÓ

Az étrend-kiegészítő használata nem helyettesíti a kiegyensúlyozott, vegyes étrendet és az egészséges életmódot.